

Main technical data for an aqueous spray cleaning machine, for cleaning heights 900, 1200, 1500 and 1800 mm.

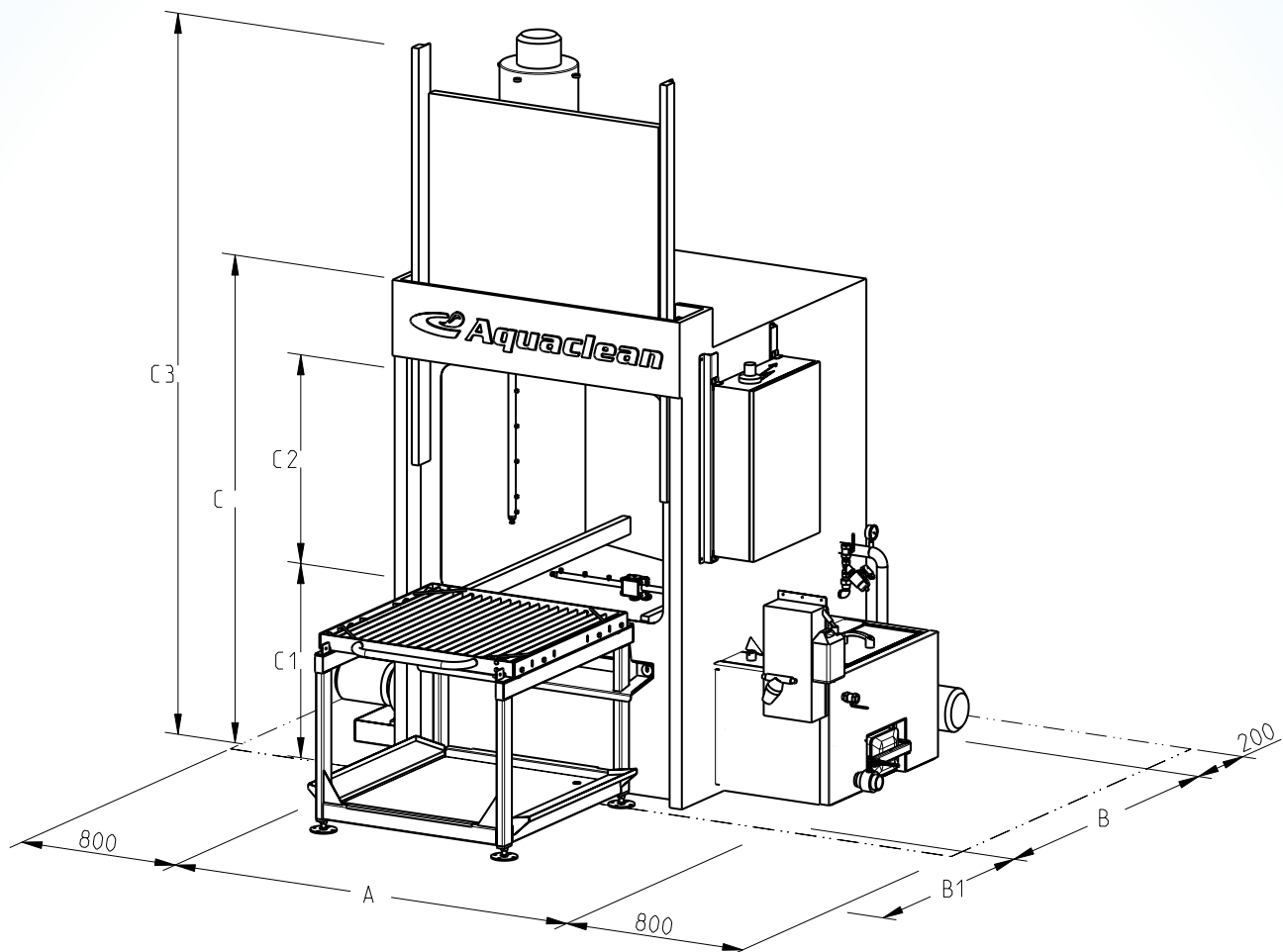

MAIN DIMENSIONS (mm)		AC-2.0LD (C2=900)	AC-2.0-C12LD (C2=1200)	AC-2.0-C15LD (C2=1500)	AC-2.0-C18LD (C2=1800)
Width	A	2950	2950	2970	2970
Depth	B	2290	2290	2290	2290
	B1	1770	1770	1770	1770
Height	C	2320	2720	3020	3320
	C1	910	910	910	910
	C2	900	1200	1500	1800
	C3	3390	3990	4590	5190
Load Carriage	L x W	1600	1600	1600	1600



TECHNICAL DATA		AC-2.0LD (C2=900)	AC-2.0-C12LD (C2=1200)	AC-2.0-C15LD (C2=1500)	AC-2.0-C18LD (C2=1800)
Tank volume	l	1600	1600	1600	1600
Heating capacity	kW	36	36	36	36
Pump flow	l/min	500	550	600	650
Pump pressure	bar	4.5	4.5	5.0	5.0
Pump motor	kW	7.5	7.5	11.0	11.0
Max. component dimensions	L x W ^{mm}	1600	1600	1600	1600
	Height ^{mm}	900	1200	1500	1800
	Diam. ^{mm}	1800	1800	1800	1800
	Weight ^{kg}	1000	1000	1000	1000
Machine weight	kg	2000	2110	2220	2330
Connection power	kW	37	37	37	37